

# POWER VISION 4

Installation Guide for: Can-Am

## Model Coverage:

2018 Can-Am X3 900 HO  
2017-2022 Can-Am X3 Turbo  
2017-2022 Can-Am X3 Turbo R  
2020 Can-Am X3 Turbo RR  
2018-2021 Can-Am Maverick Trail 800  
2018-2023 Can-Am Maverick Trail 1000  
2019-2023 Can-Am Maverick Sport 1000  
2015-2018 Can-Am Maverick 1000R  
2015-2017 Can-Am Maverick 1000R Turbo  
2015-2018 Can-Am Maverick 1000R Max  
2015-2017 Can-Am Maverick 1000R Turbo Max  
2015-2021 Can-Am Spyder F3  
2015-2021 Can-Am Spyder RT  
2016-2021 Can-Am Commander 800  
2016-2023 Can-Am Commander 1000  
2018-2021 Can-Am Defender HD5  
2018-2021 Can-Am Defender HD8  
2018-2021 Can-Am Defender HD10  
2022-2023 Can-Am Defender HD10  
2019-2023 Can-Am Outlander 850  
2019-2023 Can-Am Outlander 1000  
2019-2022 Can-Am Ryker 600  
2019-2022 Can-Am Ryker 900

**PLEASE READ ALL DIRECTIONS BEFORE STARTING INSTALLATION**



# INTRODUCTION

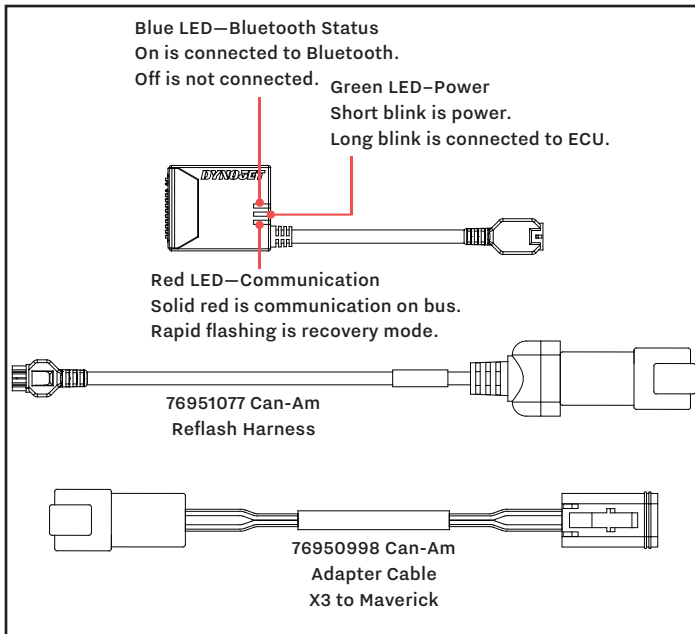

Thank you for purchasing the Power Vision 4 (PV4) from Dynojet Research. The Power Vision 4 is the most flexible and powerful flash tuning device in the world. The Power Vision 4 uses reflash technology to change the parameters inside the stock Engine Control Unit (ECU) that affects the way the engine will run.

The Power Vision 4 has three indicator lights:

- Red LED—Communication. Solid red is communication on bus; rapid flashing is recovery mode.
- Green LED—Power. Short blink is power; long blink is connected to ECU.
- Blue LED—Bluetooth status. On is connected to Bluetooth; off is not connected.

After the vehicle has been flashed, the Power Vision 4 does not need to remain connected to have full benefits of the device, however, the Power Vision 4, paired with your phone and the Dynojet PV4 app, provides a window into your vehicle. Gain access to customizable gauge screens, along with data logging screens and troubleshooting of Diagnostic Trouble Codes.

For state of the art technical support, please email [pv4tech@dynojet.com](mailto:pv4tech@dynojet.com).

# LOCATING THE DIAGNOSTIC CONNECTOR

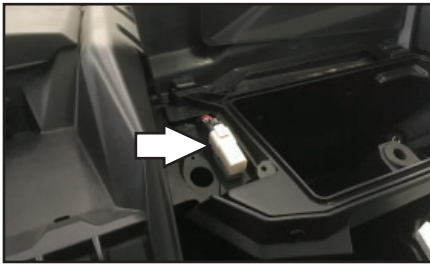

## Maverick X3 Models

The diagnostic connector is located under the glove box lid. Note: Remove the diagnostics port holder and insert the Power Vision cable to hold the cable securely in place.



## Trail Models

The diagnostic connector is located under the dash to the left of the steering column.



## Maverick Models

The diagnostic connector is located near the fuse box. Note: Remove the diagnostics port holder and insert the Power Vision cable to hold the cable securely in place.

# LOCATING THE DIAGNOSTIC CONNECTOR



## Spyder Models

The diagnostic connector is located under the front hood/luggage compartment area behind the small radiator cap access panel.



## Commander Models

The diagnostic connector is located under the dash on the driver's side near the battery and fuse box.

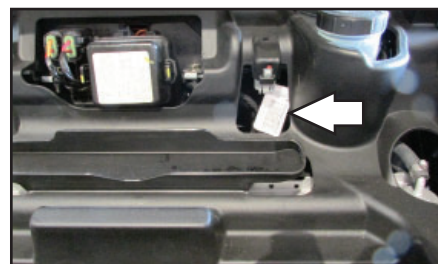

## Defender Models

The diagnostic connector is located under the front hood.



## Ryker Models

The diagnostic connector is located under the front cover.



## Outlander Models

The diagnostic connector is located under the seat.

# GETTING STARTED

- 1 Download and install the Dynojet Power Vision app from the Apple App or Google Play Store.
- 2 Verify Bluetooth and Location are enabled.  
Location permission is required for the app to access the phone's Bluetooth hardware.



- 3 Connect the Power Vision to the vehicle diagnostic port.
- 4 Turn the ignition switch to the ON position and the run switch to the RUN position, but do not start the vehicle.
- 5 Open the Dynojet Power Vision app.
- 6 Log in using your Dynojet account login information. Don't have a Dynojet account? Press **I don't have an account** and create one. Enter your information and a password and press **Register**.
- 7 Press **Scan**.
- 8 Select the Dynojet PV4.



Select the PV4

- 9 Press the **Pencil** to edit the vehicle name. Press **Update** to save.

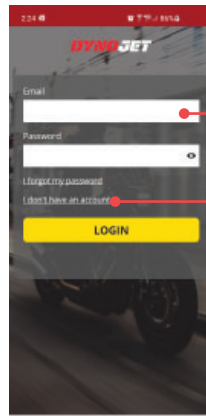

Log in

Don't have an account? Create one!

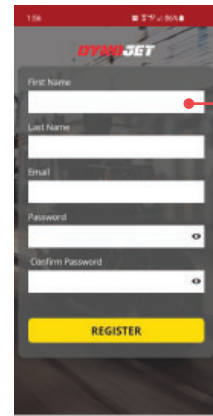

Enter your information to create an account

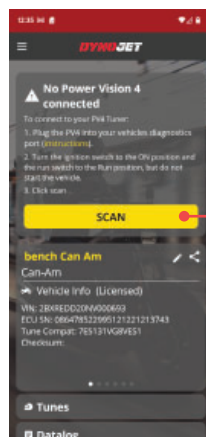

Scan for PV4

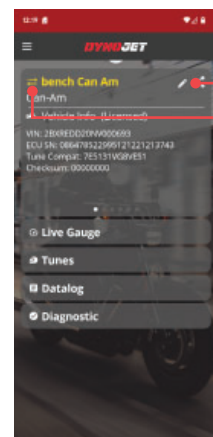

Edit pencil

Indicates the vehicle you are connected to

# FLASHING YOUR VEHICLE

Your Power Vision 4 comes with one available Tune License. Before you can flash additional vehicles, you will need to purchase additional tune licenses from [Dynojet](#).

- 1 Press **Tunes**.
- 2 Select a tune file (.djt) from the list of available Dynojet Tunes or press **Filter** to filter the list of tunes.
- 3 Tap a Filter field and select from the available options to narrow the results.
- 4 Once you have selected your filters, slide the filter screen to the left. Select a tune file from the filtered list.
- 5 Press **Flash Tune**.
- 6 Press **Yes** to use the included Tune License to lock the Power Vision 4 to this vehicle and flash the tune. **Do not** turn off the key switch or disconnect the Power Vision during the flash.

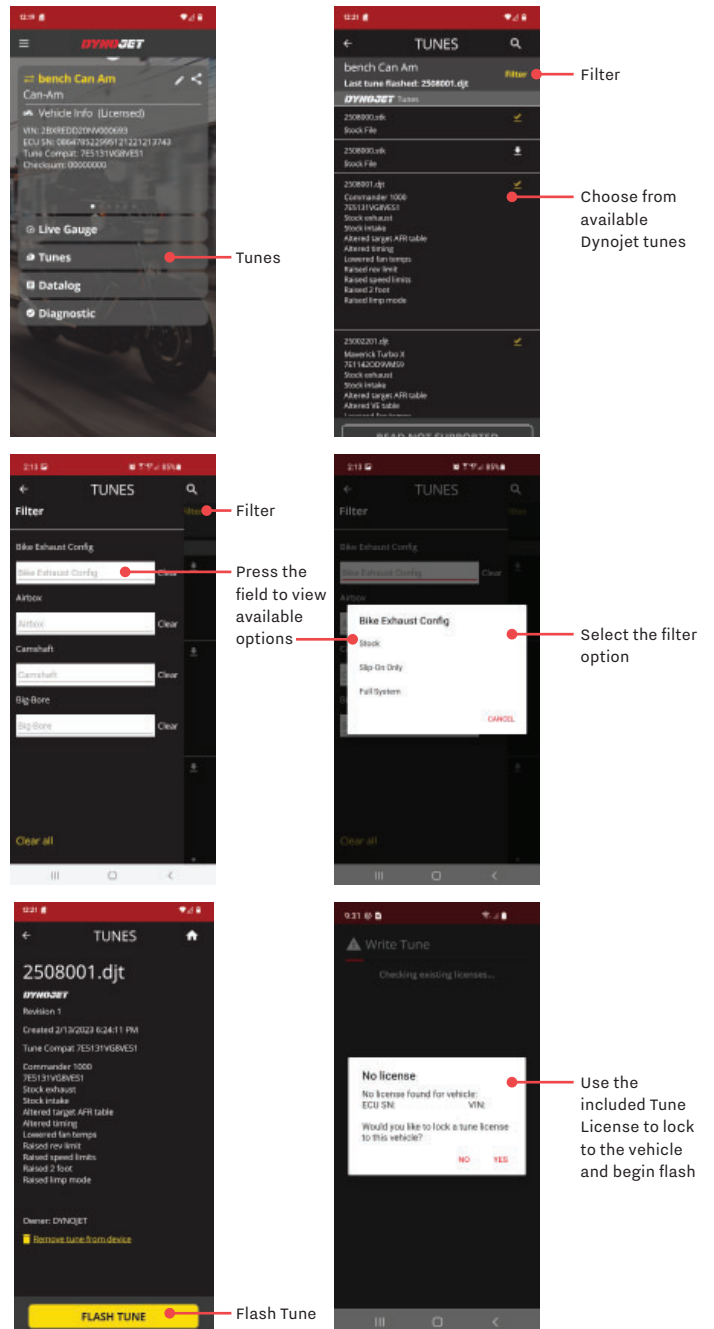

# EDITING TUNES WITH POWER CORE

Use Dynojet's Power Core software to edit the ECU tables to improve your riding experience. When you are finished editing, save the tune to the Cloud and use the Dynojet Power Vision 4 App to flash your tune to the vehicle.

- 1 Open the Dynojet Power Core software.
- 2 Open C3 Tuning.
- 3 From the Home ribbon, click **Browse Cloud**. Log in using your Dynojet account login information.  
**Note:** If you do not already have an account, you will need to create an account to use the Browse Cloud feature. Click **Create Account** and follow the on-screen instructions.

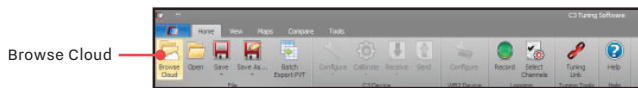

- 4 Using the drop-down arrow, select your vehicle.
- 5 Select the stock file to edit and click **Open**.
- 6 Make your desired changes to the table(s).
- 7 Click **Save As>Save to Cloud as**.
- 8 Enter a name for your tune and click **Save**.
- 9 Enter any important tune notes and click **Save**.
- 10 Return to your phone and refresh the tunes list in the app.
- 11 Select your modified tune and press **Flash Tune**.

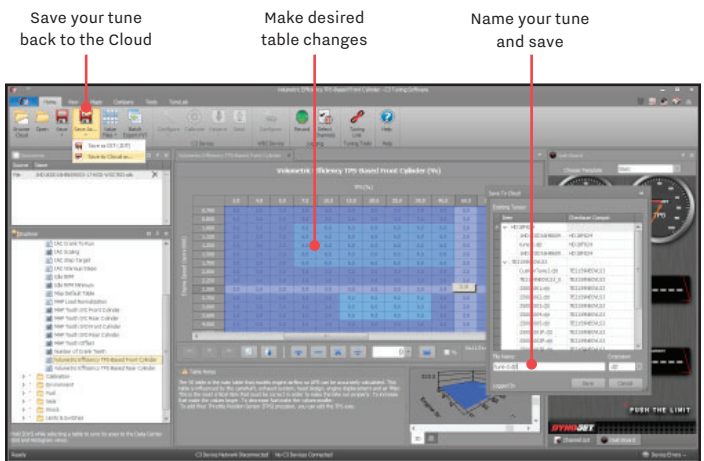
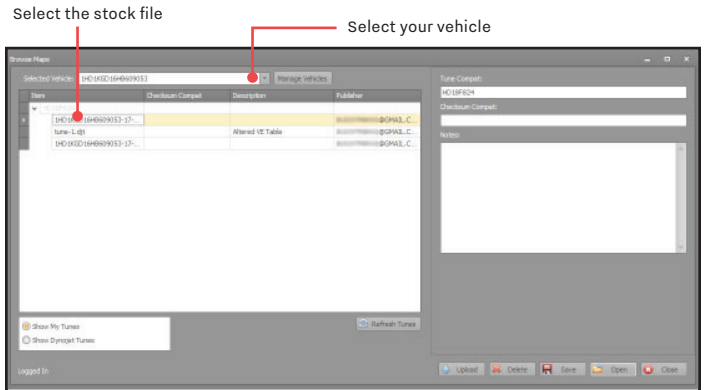

# LICENSE MANAGER

View available tokens, redeem and purchase tokens for tune licenses, and download a license to store on your phone for use off line. Your Power Vision 4 comes with one available Tune License. Tune Licenses are transferable.

- 1 Press **Menu** and press **License Manager**.
- 2 View your available tokens or press **Purchase Tokens** to purchase tokens to use for a tune license.
- 3 Press **Download** to download and store your tune license on your phone.
- 4 Press **Create License** to purchase a license for a vehicle. You will need an available token to create a license.
- 5 Press **Yes** to redeem your token for a tune license.



## 6 POWER VISION 4

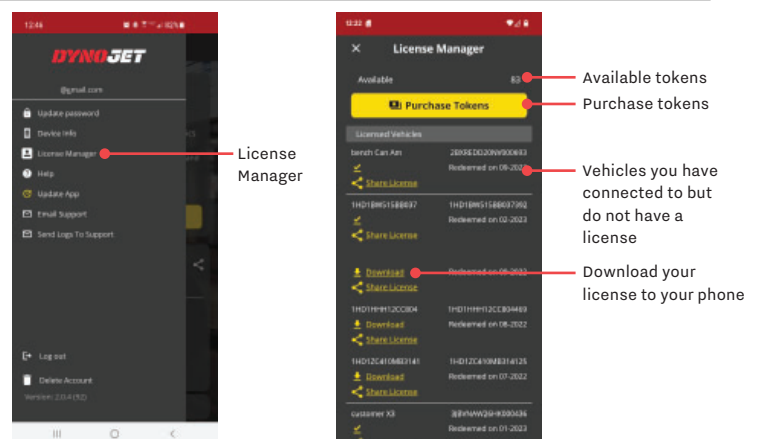

## INSTALLATION AND USER GUIDE



# VIEWING LIVE GAUGES

Your Power Vision 4 allows you to configure digital and circular gauges for real time monitoring. The Power Vision must be connected to the vehicle to view live gauges.

1 Connect the Power Vision to the vehicle diagnostic port.

2 Start the vehicle.

3 Press **Live Gauge**.

4 Press **+** to add a gauge.

5 Add a digital gauge.

- Press the **Channel** field to view a list of the available options for that field.
- Press the **Gauge Type** field and select digital.
- Press the **Precision** field and select the precision.
- Press the **Unit** field and select a unit.

6 Once you have completed your selections, press **Add Gauge**.

7 Press the **Pencil** to edit or remove the gauge.

8 Add a circular gauge.

- Press the **Channel** field to view a list of the available options for that field.
- Press the **Gauge Type** field and select circular.
- Press the **Min Value** and **Max Value** and use the number pad to enter your values.
- Press the **Precision** field and select the precision.
- Press the **Unit** field and select a unit.

9 Once you have completed your selections, press **Add Gauge**.

10 Press the **Pencil** to edit or remove the gauge.

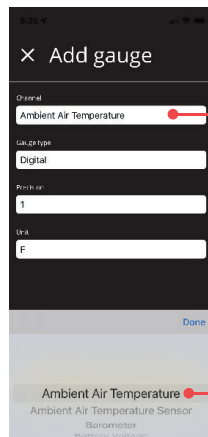
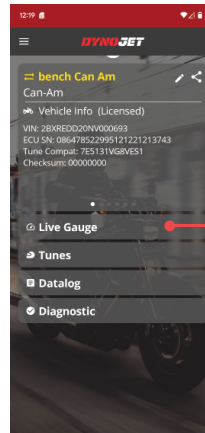

Press the field to view available options

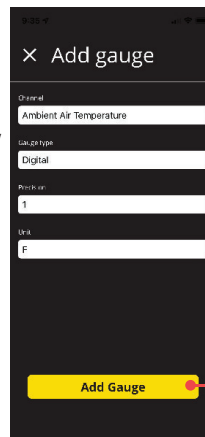

Press Add Gauge

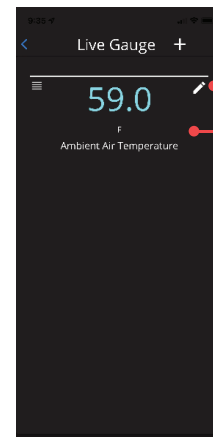

Press Pencil to edit Digital gauge added

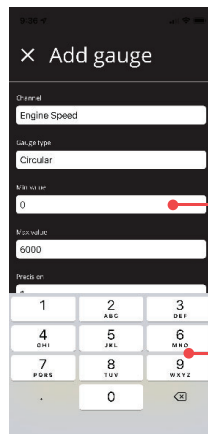

Press the field to view available options

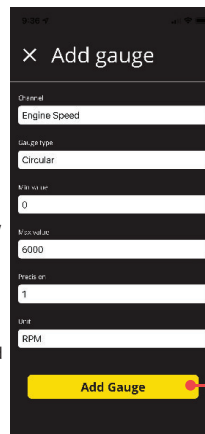

Press Add Gauge

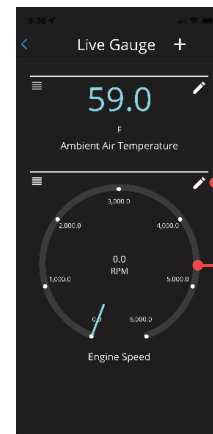

Press Pencil to edit Circular gauge added

# LOGGING DATA

The Power Vision 4 allows you to log data and view the log using Power Core Software.

- 1 Press **Datalog**.
- 2 Press **Start** to begin logging data.
- 3 Press **Lap** to save the current log and start a new log.
- 4 Press **Stop** to stop logging.
- 5 Press the **Envelope** to share your log.  
Email the log to your computer and open the log using Power Core. Refer to the Power Core Help.

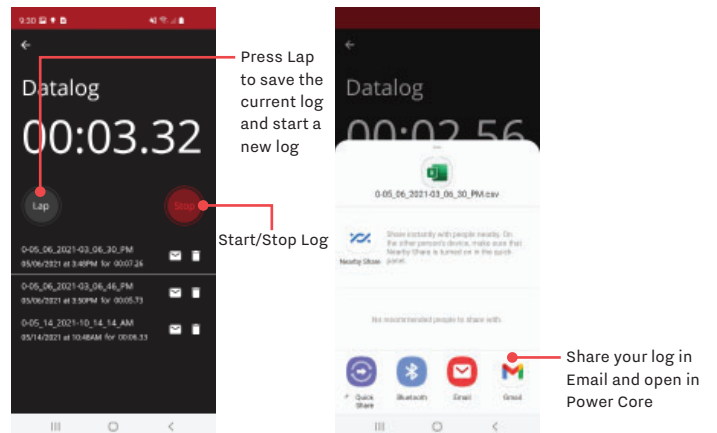

# VIEWING THE DIAGNOSTIC CODES

Diagnostics allows you to read and clear diagnostic trouble codes (DTCs).

- 1 Press **Diagnostic**.
- 2 Press **Read DTCs** to read codes.
- 3 Press **Clear DTCs** to clear the codes.
- 4 Press the **Envelope** to share your log.  
If requested by Dynojet Technical Support, Email the file to [pv4tech@dynojet.com](mailto:pv4tech@dynojet.com).

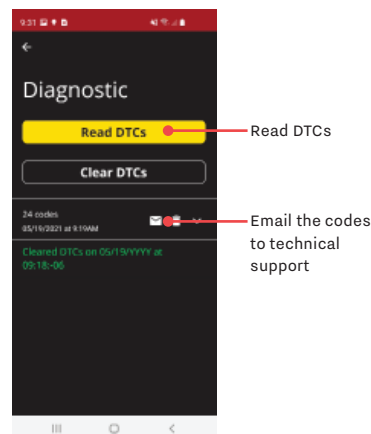



# VIEWING THE DEVICE INFORMATION

Device Information allows you to view the Power Vision 4 firmware version, serial number and address, and copy the device information if needed, while Firmware type allows you to toggle between brands of firmware.

Note: Changing the firmware type will require you to use the correct diagnostic cable.

- 1 Press **Tunes** and press **Device Info**.
- 2 Press **Copy device information** to save a copy of the device information to your clipboard.
- 3 Press the **Firmware type** brand name to view a list of the available options.
- 4 Scroll through the brands and select a brand.
- 5 Press the **X** to close and initiate the firmware update.
- 6 Press **Yes** to confirm the firmware update.

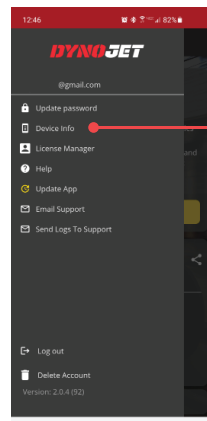

View the Device Info

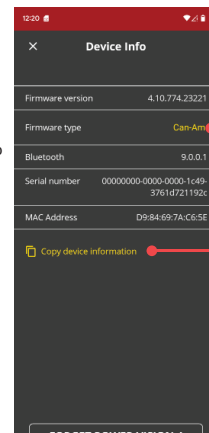

Press for firmware type

Copy the device info

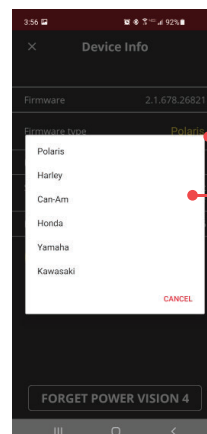

Firmware type

Available options

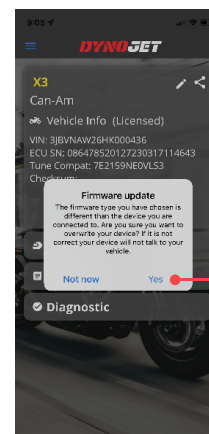

Confirm firmware change

# DISCONNECTING FROM THE POWER VISION 4

Manually disconnect from your Power Vision 4 and connect to another device.

Press **Menu** and press **Device Info** and press **Forget Power Vision 4**.

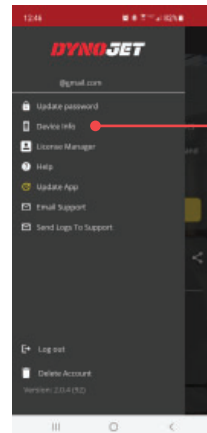

Press Device Info

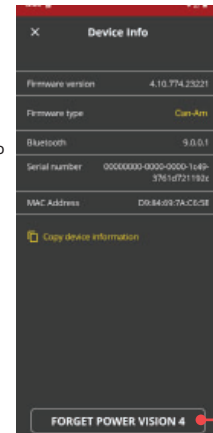

Disconnect from Power Vision 4

# UPDATING THE APP

Check for updates and update the Dynojet Power Vision app.

- 1 Press **Menu** and press **Update App**.
- 2 Follow the prompts to continue the update process.

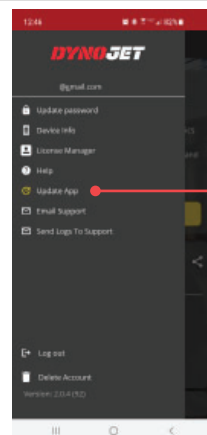

Press Update App

# REPORT A PROBLEM

Have questions, a problem, or need additional support? Email Dynojet's state of the art technical support team.

- 1 Press **Menu** and press **Report a Problem**.
- 2 Select which email app to use.

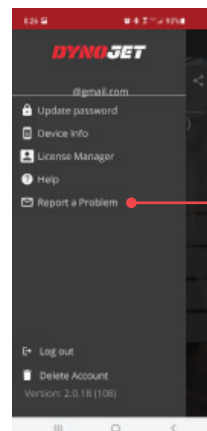

Press Report a Problem

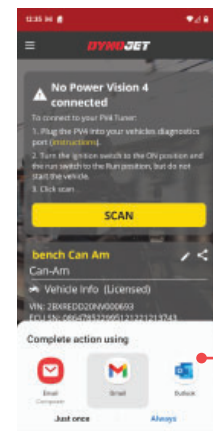

Choose an email app to use

# SHARING THE VEHICLE INFORMATION

Share the Power Vision 4 vehicle information for diagnostic purposes.

Press **Share** and using the share dialog, send your vehicle information for diagnostic purposes.

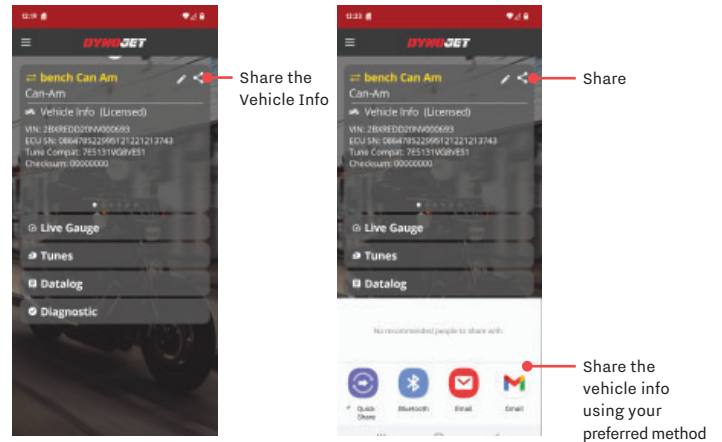

# INSTALLING THE POWER CORE SOFTWARE

Download the Power Core software and take tuning to a whole new level.

**Note:** Downloading the Power Core software is optional and not necessary to use the Power Vision.

- 1 Go to [www.dynojet.com/PowerVision](http://www.dynojet.com/PowerVision).
- 2 From the top navigation menu, select **Support**>**Downloads**.
- 3 Click **Power Core Software Download**.
- 4 Double-click the saved file to begin installation. Follow the on-screen prompts. Refer to the Power Core Help for more information.

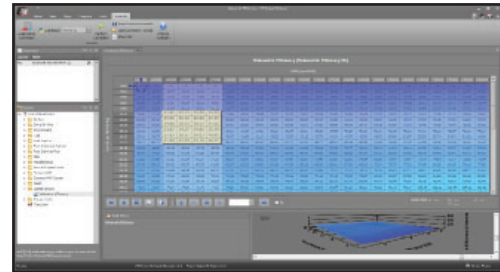

# TROUBLESHOOTING

A few of the more common troubleshooting topics are listed below. For more topics visit the [Dynojet Knowledge Base](#). For additional help, please contact [Dynojet Technical Support](#).

## UNABLE TO CONNECT TO BLUETOOTH

- 1 Verify you are within range.
- 2 Turn Bluetooth off and then on again.
- 3 Restart your phone. Restart the Power Vision 4.
- 4 Have your phone “forget” the Power Vision 4.
- 5 Clear the Bluetooth cache.

## PHONE WILL NOT CONNECT TO POWER VISION 4

Location permission is required for the app to access the phone's Bluetooth hardware.

- 1 Locate the Dynojet Power Vision 4 app on your phone.
- 2 Long-press the app until the context menu appears.
- 3 Press **App Info** or the ⓘ icon.
- 4 Press **Permissions**.
- 5 Verify Location and Storage are both allowed.

## ERROR FLASHING

- 1 Verify the Power Vision 4 app is up to date through either the Apple App Store or Google Play Store.
- 2 Connect the Power Vision 4 to your bike.
- 3 Verify the firmware is up to date.
- 4 Install the firmware update(s) if available.
- 5 Contact [Dynojet Technical Support](#) if the error persists.

## HOW TO RECOVER THE ECU

You may need to recover the ECU if the flash was interrupted leaving the ECU in an incomplete flash state.

- 1 The Power Vision 4 will ask you to recover the ECU. Press **OK**. This will automatically flash the stock (.stk) file.
- 2 If the Power Vision 4 does not automatically flash the stock (.stk) file, you will need to manually choose a stock (.stk) file from your tunes. Ideally, this would be the stock (.stk) file you saved from your initial read.
- 3 Once the ECU is recovered, you will need to re-flash your tune.

## HOW TO UPDATE THE FIRMWARE

- 1 Every time you connect to the Power Vision 4, the device automatically checks for new firmware. If newer firmware is found, the Power Vision 4 will ask you to update the device.
- 2 Press **Yes** to update the device.
- 3 You must update the device to continue. If you choose not to update the device, the app will close.

## 12 POWER VISION 4

## HOW TO MANAGE EXISTING TUNE LICENSES

Manage your existing Tune Licenses on the Dynojet website.

- 1 Log in to your [Dynojet.com](#) account using the same account you used to log in to the Power Vision 4 app.
- 2 Click **My Account** in the top, right corner of the browser.
- 3 Click **Tune Licenses**.

## NO TUNE LICENSE AVAILABLE

Your new Power Vision 4 comes with one available tune license. Before you can flash additional vehicles, you will need to purchase additional tune licenses.

- 1 Log in to your [Dynojet.com](#) account.
- 2 Click **My Account>Tune Licenses**. View your purchased licenses. This will also show you which VIN the license file is associated with.
- 3 Purchase additional tune licenses to use with additional vehicles.

## HOW TO PURCHASE A TUNE LICENSE

Through a Tune License, you can unlock the true potential of your Dynojet Power Vision 4. Your Power Vision 4 will be able to tune the original vehicle, as well as additional vehicles. Your Power Vision 4 device will remember each license that is applied, essentially multiplying the power of your device.

Each license is vehicle specific, not device specific, allowing you to load a Tune License onto any number of Power Vision units you have.

- 1 Visit <https://www.dynojet.com/tuning-licenses/>.
- 2 Log in to your Dynojet account.
- 3 Select the Tune License for the vehicle you wish to purchase and add to your cart.
- 4 Check out following the prompts.

## UNABLE TO LOG INTO MY DYNOJET ACCOUNT

- 1 Verify there is not a typo in your email or password.
- 2 Verify you have entered your full email address. For example, “username@dynojet.com” instead of “username@dynojet.”
- 3 Passwords are case sensitive. Verify caps lock is turned off.
- 4 Refresh your browser and try signing in again.
- 5 Did you forget your password? Click **Forgot my password** and follow the prompts.
- 6 Still having trouble, contact [Dynojet Technical Support](#).

## INSTALLATION AND USER GUIDE



# TRUTH IN PERFORMANCE

2191 MENDENHALL DRIVE, NORTH LAS VEGAS, NV 89081 - 800-992-4993 - [DYNOJET.COM](http://DYNOJET.COM)

© 2021-2023 DYNOJET RESEARCH ALL RIGHTS RESERVED