



# Extreme Sub ES08

Models: GDI-EXESW800...20

POWERSPORTS + GOLF CARS + MARINE

# SUBWOOFER



## User Guide

# Extreme Sub Layout

Backlit Subwoofer (Passive)

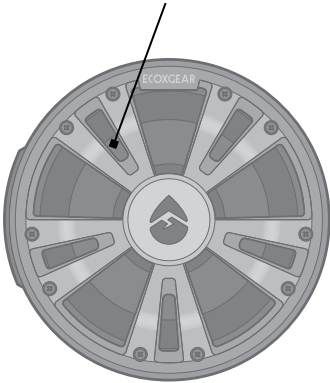

RIGHT SIDE

Control Panel

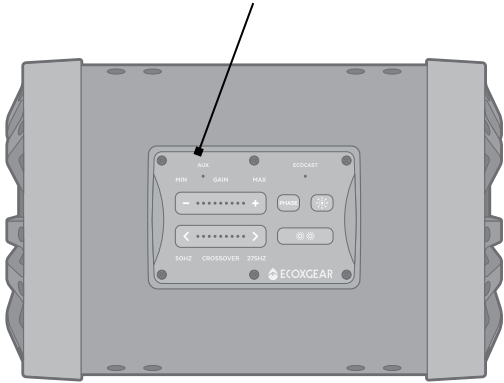

FRONT

Auto-Turn-On Switch

Backlit Subwoofer

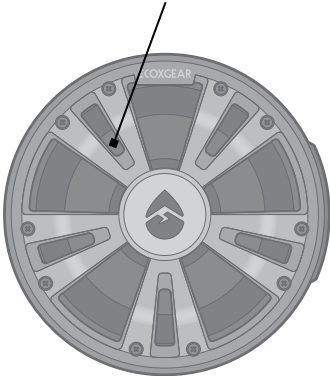

LEFT SIDE

Heat Sink

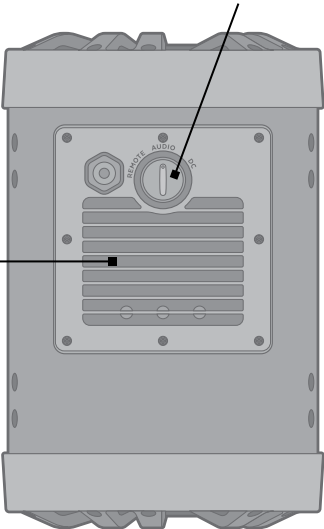

BACK

# In/Out Connections

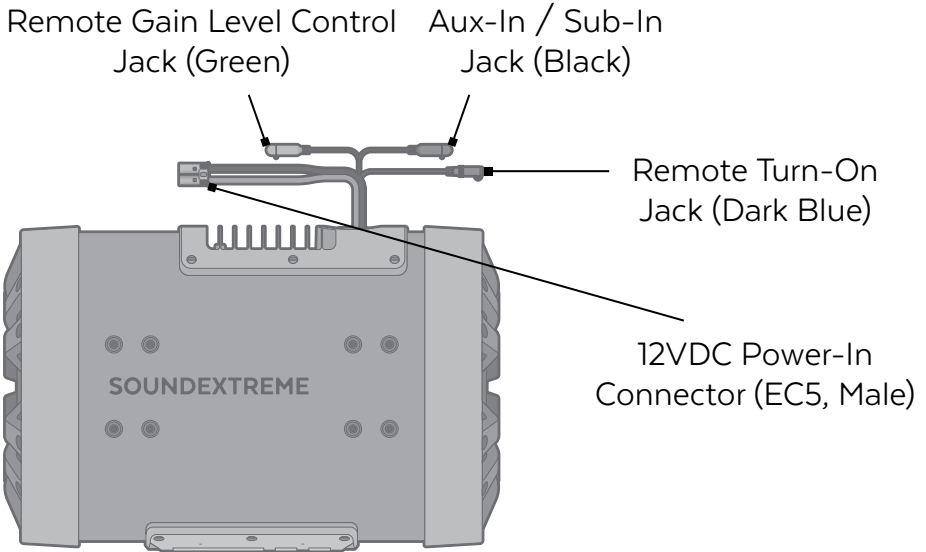

Do **NOT** use these connections if they are wet.

**Aux-In / Sub-In Jack:** If you do not want to connect the Extreme Sub wirelessly via EcoCast or want to connect it to a non-ECOXGEAR amplifier or speaker, you can connect the subwoofer using this input and the supplied 3.5mm Audio Cable. Connect it to any brand of stereo, amplifier, or soundbar's wired subwoofer-out or line-out.

**Remote Gain Level Control Jack:** This input can be connected to the supplied Remote Gain Level Controller, which allows for easy adjustment of the Extreme Sub's overall output.

**Remote Turn-On Jack:** This input can be used to turn on or turn off the Extreme Sub by another device. When the Auto-Turn-On Switch is turned to "Remote," a 12VDC signal (e.g. a vehicle ignition signal) will turn on the Extreme Sub. A (Dark Blue) Remote Turn-On Cable has been provided for your convenience.

**12V Power-In Connector:** This connector is used to connect to an external 12VDC power supply, with a minimum of a 30A current rating, via the supplied 6.6ft Power Cable (EC5, female).

# Connecting to 12VDC Power Supply

The Extreme Sub does not have an internal battery. It must be connected to an external 12VDC power supply to function. Before you connect the Extreme Sub to a battery or a voltage regulator on a golf cart, a boat, a quad bike, a UTV, or another vehicle, you need to confirm the following:

1. Your vehicle battery or battery pack's terminal voltage is 12VDC.
2. Your vehicle battery or battery pack can supply a 30A current rating to the Extreme Sub.

If both an Extreme Sub and an ECOXGEAR SoundExtreme soundbar are connected to the same battery or battery pack, it requires a 40A current rating supply. So, before connecting to the vehicle's power supply, please check your vehicle's electrical specifications, or consult with the vehicle's manufacturer or distributor.

If the battery terminal voltage is not 12V, it requires a DC-DC converter with output 12V and 30A or 40A rating, as explained above.

Connecting the Extreme Sub to a non-12VDC power source will lead to a malfunction or damage to the subwoofer.

On electric vehicles, a DC-DC converter is required to avoid damage to the unit and the vehicle.

The accessory power output on the SoundExtreme soundbar (sold separately) does not have enough current capacity to supply the Extreme Sub. Do **NOT** connect the Extreme Sub Power-In Connector to the SoundExtreme accessory power output.

In addition to the power input connections, it is necessary to choose an Auto-Turn-On mode and connect the corresponding external control signal, so that the Extreme Sub can turn on and off as expected. Please refer to **Auto-Turn-On Mode and External Control** for details.

## Installation: Gas Vehicle

1. Loosen the nuts on the battery terminals.

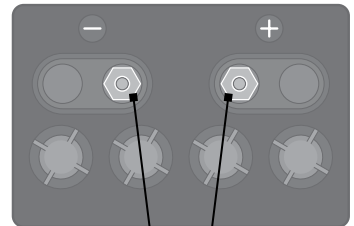

Loosen Nuts

**Use Caution:** Do **NOT** attempt to loosen nuts if battery is wet. Contact may cause electric shock and injury if wet.

2. Connect the **BLACK** wire to the **BLACK**, negative terminal.
3. Connect the **RED** wire to the **RED**, positive terminal. Unit will not work correctly and may be damaged if wires are not correctly attached.

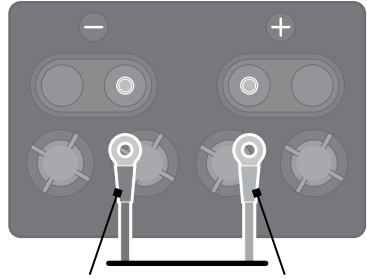

Black Cable    Red Cable

4. Tighten the nuts on the battery terminals until the connectors are held firmly in place.
5. Connect the (EC5) female connector on the 6.6ft Power Cable to the (EC5) male 12VDC Power-In Connector.

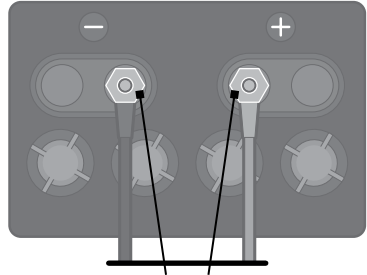

Tighten Nuts

**Use Caution:** Do **NOT** connect to 12V Battery if the 6.6ft Power Cable or the (EC5) Power-In Connector are wet. Contact may cause electric shock and injury if wet.

6. Turn the Auto-Turn-On Switch toward, “DC” in order to turn on the subwoofer.

**Tip:** Use zip ties to gather any excess wires, and secure them so that they are not dangling, loosely.

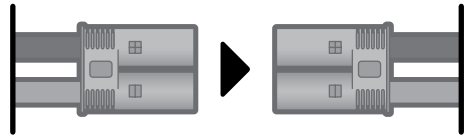

EC5, Female

EC5, Male



Turn Auto-Turn-On Switch to DC

## Installation: Electric Vehicle

1. Switch your vehicle to TOW mode.
2. Wire the **BLACK** wire on the Extreme Sub power cable to the **GROUND** on output of the DC-DC Converter.
3. Wire the **RED** wire on the Extreme Sub to the **POSITIVE (+)** post on the output of the DC-DC converter. Unit will not work correctly and may be damaged if wires are not correctly attached.
4. Connect the (EC5) female connector on the 6.6ft Power Cable to the (EC5) male 12VDC Power-In Connector.
5. Connect the (EC5) female connector on the 6.6ft Power Cable to the (EC5) male 12VDC Power-In Connector.

**Use Caution:** Do **NOT** connect to DC-DC converter if the 6.6ft Power Cable or the (EC5) Power-In Connector are wet. Contact may cause electric shock and injury if wet.

4. Turn the Auto-Turn-On Switch toward, "DC" in order to turn on the subwoofer.

**Tip:** Use zip ties to gather any excess wires, and secure them so that they are not dangling, loosely.

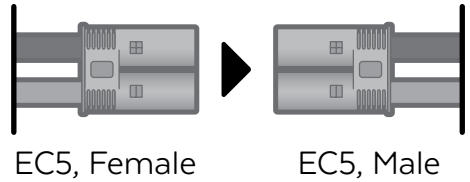
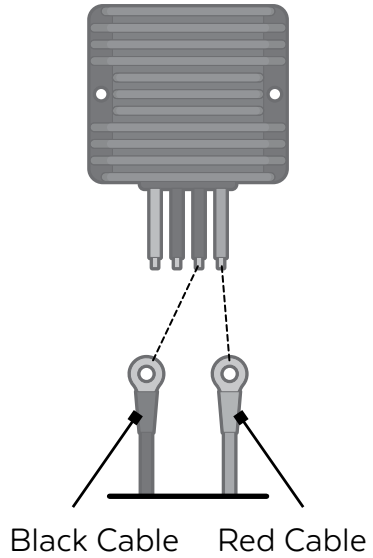

Turn Auto-Turn-On Switch to DC

# Controls

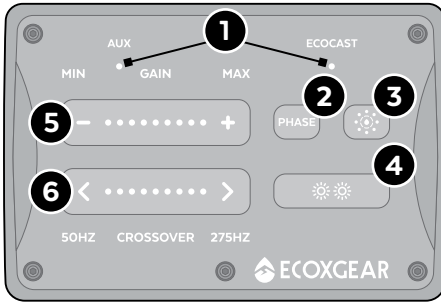

CONTROL  
PANEL



AUTO-TURN-  
ON SWITCH

1. **LED Indicators:** Each of the 2 LEDs correspond to different functions: AUX, Phase, and EcoCast Receiving.
2. **Phase Button:** Press this button to toggle the Extreme Sub sound output from in phase to out of phase. If the AUX LED flashes Green 3 times, the sound output is in phase. If the AUX LED flashes Red 3 times, the sound output is out of phase.
3. **EcoCast Button:** When turned on, the Extreme Sub enters EcoCast Receiving Mode. If it is not paired with a SoundExtreme, press this button to put the Extreme Sub into Pairing Mode.
4. **Party Lights Button:** Press to cycle through the following 12 Party Light Modes: Red, Orange, Yellow, Green, Cyan, Blue, Purple, White, Music Sync, FADE7, JUMP7, Color Fade. Press and hold to turn off the Party Lights.
5. **Gain Control Buttons:** Press to increase or decrease the gain level of the Extreme Sub. The Gain Controls allow you to change the relative value of the Extreme Sub compared to the SoundExtreme.
6. **Crossover Control Buttons:** Press to decrease or increase the frequency range of the Extreme Sub. Reducing the Crossover Frequency will result in the Extreme Sub performing solely as a low frequency subwoofer.
7. **Auto-Turn-On Switch:** Turn the switch to select one of three Auto-Turn-On modes: Remote, Audio, and DC.

# Operations

## Auto-Turn-On Mode and External Control

Use the Extreme Sub's Auto-Turn-On Switch to select from 3 turn on/off modes, (each corresponding to a different external control signal connection): DC Mode, Audio Mode, and Remote Mode.

### 1. DC Mode (Factory Default Setting)

When the Auto-Turn-On switch is turned to the **DC** position, the Extreme Sub will be turned on whenever there is a 12VDC power supply. On this mode, there is no button on the Control Panel or external signal control to turn the unit off.



If you don't have an external control signal connection, you can turn the Auto-Turn-On switch to the **Audio** position to put the Extreme Sub into standby mode, reducing power consumption, when not in use.

### 2. Audio Mode

When the Auto-Turn-On switch is turned to the **Audio** position, the Extreme Sub will be turned on and enter standby mode based on the audio signal input at the Aux-In / Sub-In Jack. So, it is necessary to have an Aux-In connection from an audio source such as a soundbar, an amplifier, or a stereo receiver. Please refer **Aux-In Audio Connection** for details.



If no audio signal input has been detected, the Extreme Sub will enter standby mode after 10 minutes, (e.g. the audio playback has been stopped). While in standby mode, all the LEDs on the Control Panel



will be turned off, and the Extreme Sub will still draw power but at a very low power consumption.

### 3. Remote Mode

If you want to use your vehicle ignition signal to turn on or off the Extreme Sub, turn the Auto-Turn-On switch to the **Remote** position, and connect the (Dark Blue) Remote Turn-On Jack to the vehicle ignition switch with the supplied (Dark Blue) Remote Turn-On Cable.



The Extreme Sub will turn on or off when the vehicle ignition is on or off.

#### Remote Mode: Connecting to a Switch

If you don't have a vehicle ignition signal connection, or want to use a switch to turn the Extreme Sub on or off, follow the steps below.

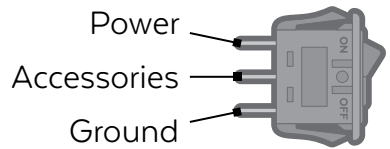

- i. Turn the Auto-Turn-On switch to the **Remote** position.
- ii. Connect the (Dark Blue) Remote Turn-On Jack to the Accessories terminal of your switch with the supplied (Dark Blue) Remote Turn-On Cable.

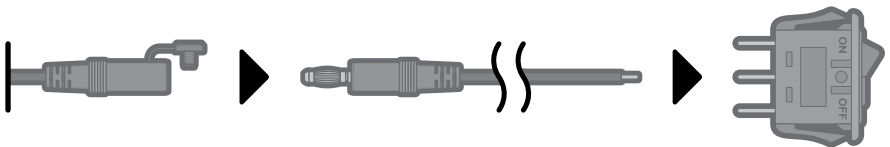

- iii. Connect the Power terminal of your switch to your vehicle battery 12VDC terminal with a cable that comes with your switch.

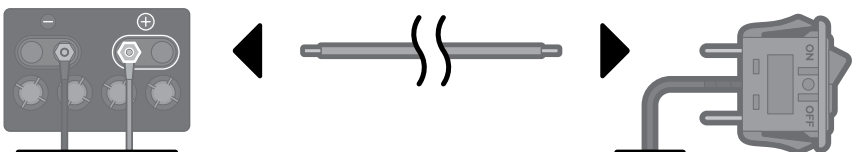

**Important:** Only connect to a battery terminal with 12VDC output. If you connect to a higher voltage (like 24V, 36V or 48V), it will damage the Extreme Sub and void the product warranty.

iv. Once the connections are completed, the Extreme Sub will turn on or off when the switch is turned on or off.

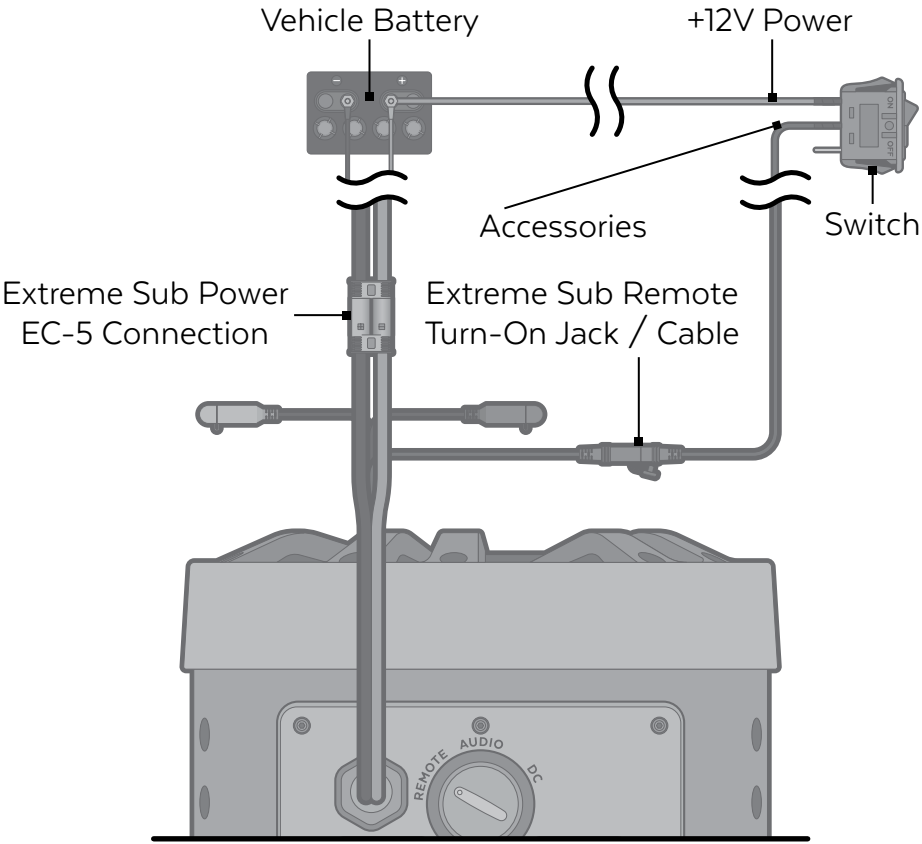

**Remote Mode: Connecting to a Power Panel or Switch Panel**

If your vehicle has a power panel or switch panel and you are familiar with all of the switch connections on the panel, you can use a switch on the panel to turn the Extreme Sub on or off with the following steps.

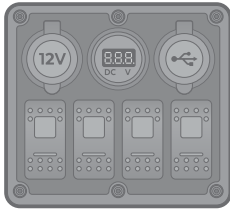

i. Turn the Auto-Turn-On switch to the **Remote** position.

- ii. Find a terminal on a switch that has 12VDC output when the switch is on and 0VDC output when the switch is off.

**Important:** Only connect to a terminal with 12VDC output. If you connect to a higher voltage (like 24V, 36V or 48V), it will damage the Extreme Sub and void the product warranty.

- iii. Connect the (Dark Blue) Remote Turn-On Jack to the switch terminal with the supplied (Dark Blue) Remote Turn-On Cable.

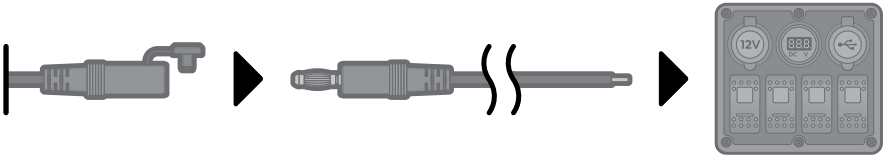

- iv. Once the connection is completed, when the vehicle is on, the Extreme Sub will turn on or off when the switch on the panel is turned on or off.

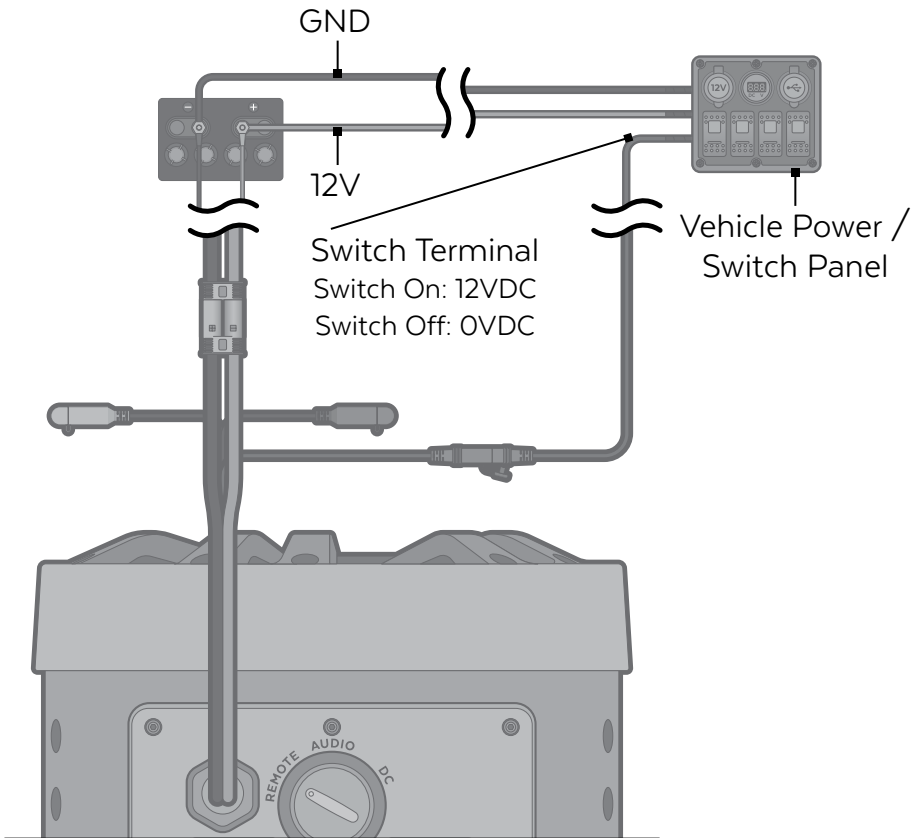

# LED Indicators

There are two LED Indicators at the top of the Control Panel. The left LED Indicator corresponds to AUX and Phase, and the right LED Indicator corresponds to EcoCast Receiving.

## 1. **AUX**

Solid Blue: When an Aux-In cable is plugged in

### **Phase - Sound Output**

When the Phase Button has been pressed, the AUX LED flashes 3 times to indicate if the Extreme Sub sound output is in or out of phase.

Flashing Green: Sound output is in phase

Flashing Red: Sound output is out of phase

## 2. **ECOCAST**

Flashing Green: EcoCast Receiving Mode - Pairing

Solid Green: EcoCast Receiving Mode - Paired

# Phase Button

Press **PHASE** briefly to toggle the Extreme Sub sound output from in phase to out of phase. If the AUX LED flashes Green 3 times, the sound output is in phase. If the AUX LED flashes Red 3 times, the sound output is out of phase.

**Note:** Pairing multiple subwoofers, depending on their location to one another, can result in the subwoofers sounding out of phase with each other and a reduction in their overall, perceived volume output. Toggle the **PHASE** button to determine which setting provides the optimal bass performance.

# Adjust Gain



Press **—** briefly to reduce the gain. Press **+** briefly to increase the gain.

The LEDs between the Gain Control Buttons indicate the gain level. When increased, the LEDs will light up, towards the right. When decreased, the LEDs will turn off, towards the left.

## Notes:

- When you adjust the volume level on your connected ECOXGEAR SoundExtreme soundbar, the volume level will adjust automatically on the Extreme Sub. The gain controls allow you to change the relative value of the subwoofer compared to the soundbar.
- The Gain Control Buttons control the sensitivity of the amplifier built into the subwoofer. You will want to optimize the gain level of the subwoofer depending on the type of music you enjoy as well as the location of the Extreme Sub.

## Adjust Crossover

Press  briefly to reduce the frequency range that the amplifier sends to the subwoofer. Press  briefly to increase the frequency range.

The LEDs between the Crossover Control Buttons indicate the frequency level. When increased, the LEDs will light up, towards the right. When decreased, the LEDs will turn off, towards the left.

## Notes:

- When the crossover frequency is set to 275Hz, you receive the full range of the Extreme Sub's capability. This allows it to play low woofer frequencies, not just subwoofer frequencies, to produce a more full sound profile when paired with ECOXGEAR SoundExtreme soundbars.
- When the crossover frequency is reduced down to 50Hz, the Extreme sub will perform solely as a low-frequency subwoofer.

## Party Lights

Press  briefly to cycle through 12 Party Light Modes: Red, Orange, Yellow, Green, Cyan, Blue, Purple, White, Music Sync, FADE7, JUMP7, Color Fade.

**PRESS AND HOLD**  to turn off the Party Lights.

# EcoCast – Broadcast Your Music to Multiple Speakers and Extreme Subs



The ECOXGEAR SoundExtreme speaker is designed to be paired with one or more SoundExtreme speakers and Extreme Subs. You can build a broadcast system by initiating EcoCast Transmitting Mode in one SoundExtreme speaker and broadcasting your music to one or more Extreme Subs and SoundExtreme speakers in EcoCast Receiving Mode.

**Note:** The Extreme Sub is always in EcoCast Receiving Mode.

## EcoCast: SoundExtreme to Extreme Sub

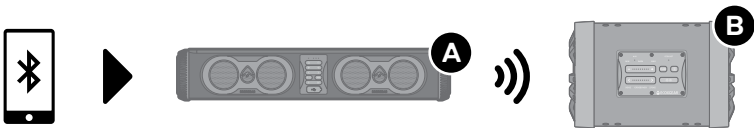

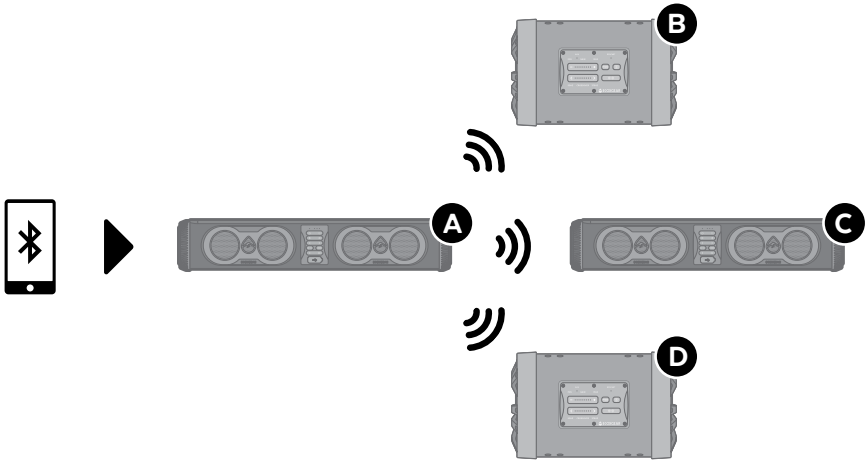

1. Follow the **Pairing a Bluetooth Device** instructions in your SoundExtreme user guide to connect one SoundExtreme (**Speaker A**) to your Bluetooth device. After your device is connected to **Speaker A**, you can select a song to play.
2. Press **MODE** on **Speaker A** to initiate EcoCast Transmitting Mode. The Mode LED Indicator (the third LED Indicator from the left) will flash Red, and the speaker will announce, “EcoCast transmitting.”
3. Power on your Extreme Sub (**Sub B**). It will already be in EcoCast Receiving Mode. The subwoofer will announce, “EcoCast receiving.”
4. Once the connection between the speakers is successful, **Sub B** will announce, “Connection Successful,” and start playing music from your Bluetooth device.

## EcoCast: Additional Receiving Speakers and/or Subwoofers



1. Power on the additional SoundExtreme speaker(s) (**Speaker C** and **Sub D**). Press **MODE** on **Speaker C** to cycle through to and initiate EcoCast Receiving Mode. The Mode LED Indicator will flash Green, and the speaker(s) will announce, “EcoCast receiving.”
2. On **Speaker A** (the speaker with the Mode LED Indicator shining solid Red), **PRESS AND HOLD MODE** for 6 seconds. The Mode LED Indicator will flash Red.
3. Once the connection between the speakers is successful, **Speaker C** (and **Sub D**) will announce, “Connection Successful,” and start playing music from your Bluetooth device.

### Notes:

- If all the speakers are turned off, then turned on, the speaker(s) and sub(s) in EcoCast Receiving Mode (**Speakers** and **Subs B, C, and D**) will automatically re-connect to the speaker in Transmitting Mode (**Speaker A**). If they are not automatically re-connected, please follow the above steps. To clear pairing records on an Extreme Sub, **PRESS AND HOLD**  for 6 seconds.
- You can also pair the SoundExtreme with any other ECOXGEAR speaker bearing the EcoCast symbol .

- The EcoCast functionality is only available while using Bluetooth as your Audio Source at a maximum range of 30 feet between speakers.
- While connecting the SoundExtreme speakers, make sure that the speakers are within a few feet of each other.
- If you do not want to connect the subwoofer wirelessly or want to connect it to a non-ECOXGEAR amplifier or speaker, you can connect the subwoofer via its Aux-In / Sub-In Jack, using the supplied 3.5mm Audio Cable.

## Aux-In Audio Connection



To use an Aux-In audio source, connect the audio output from the source unit to the Extreme Sub's Aux-In / Sub-In Jack with the supplied 3.5 Audio Cable.

Once the 3.5mm Audio Cable is plugged in, the Aux-In LED Indicator will shine solid Blue.

## Remote Gain Level Controller



1. Mount the Remote Gain Level Controller in an accessible location. Keep the cable away from the vehicle's electrical wiring to avoid possible interferences from the vehicle's electrical system.





2. Connect the Remote Gain Level Controller to the (Green) Remote Gain Level Control Jack on the Extreme Sub. The LED on the Remote Gain Level Controller will shine solid Red if the Extreme Sub is turned on.
3. Turn the knob to adjust the gain level.

## Important: Maintaining Waterproofness

If the caps on the Aux-In, Remote Gain Level Control, and Remote Turn-On jacks are not properly closed, the unit is **NOT** waterproof.

To close the Aux-In, Remote Gain Level Control Connector, and Remote Turn-On jacks properly, push firmly to be sure the cap snaps securely into place.

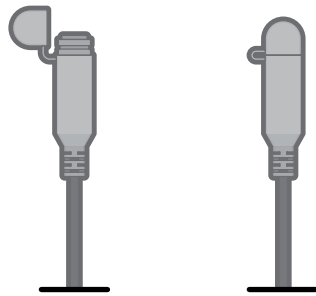

Open

Closed

# Mounting Your Subwoofer

## Use Caution:

- The Extreme Sub weighs 17 lbs. Please use caution when lifting or handling.
- The Extreme Sub vibrates when playing heavy bass music at maximum gain. It is important to fasten the subwoofer securely to a flat surface on the vehicle. Whether mounting the subwoofer horizontally or vertically, the supplied Washers and Lock Washers **MUST** be used.
- There is a Heat Sink on the back of the Extreme Sub. For optimal performance, install the subwoofer so that the Heat Sink is not in direct sunlight.

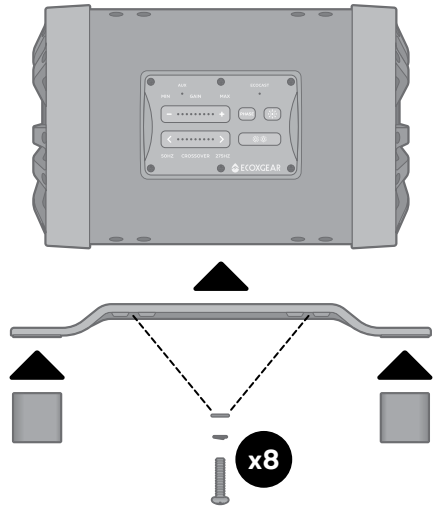

## Horizontal Mount

1. To mount the subwoofer in a horizontal orientation, first attach the Horizontal Mounting Plate, using eight 29/32" Screws, Lock Washers, and Washers. Tighten securely.
2. Ensure that the subwoofer fits in the desired location and mark where the mounts will be attached to your vehicle.
3. Drill holes at the desired mounting points on your vehicle, large enough for the provided Hex Bolts to fit.

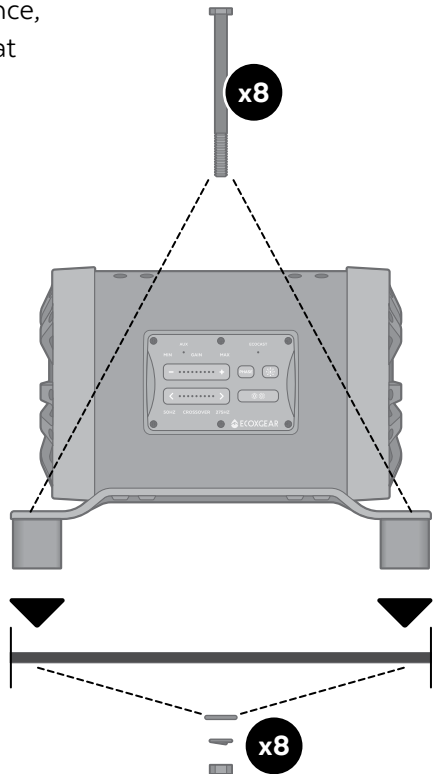

**Optional:** Place the Mount Standoffs under both ends of the Mounting Plate. Use these optional Standoffs when there is not enough clearance between the Mounting Plate and the vehicle's mounting surface.

4. Attach the Mounting Plate to your vehicle with the provided ¼-20 Hex Bolts, Washers, Lock Washers, and Nuts. Tighten securely.

## Vertical Mounts

1. To mount the subwoofer in a vertical orientation, first attach both Vertical Mounting Plates to either side of the subwoofer, using four 29/32" Screws, Lock Washers, and Washers on either side. Tighten securely.
2. Ensure that the subwoofer fits in the desired location and mark where the mounts will be attached to your vehicle.
3. Drill holes at the desired mounting points on your vehicle, large enough for the provided Hex Bolts to fit.
4. Attach the Mounting Plates to your vehicle with the provided ¼-20 Hex Bolts, Washers, Lock Washers, and Nuts. Tighten securely.

**Note:** When the Control Panel is facing you, the Extreme Sub's active subwoofer is on the left side. Depending on your vehicle, the active or passive subwoofer may sound better facing down. Please listen to the Extreme Sub oriented both ways before finalizing the installation.

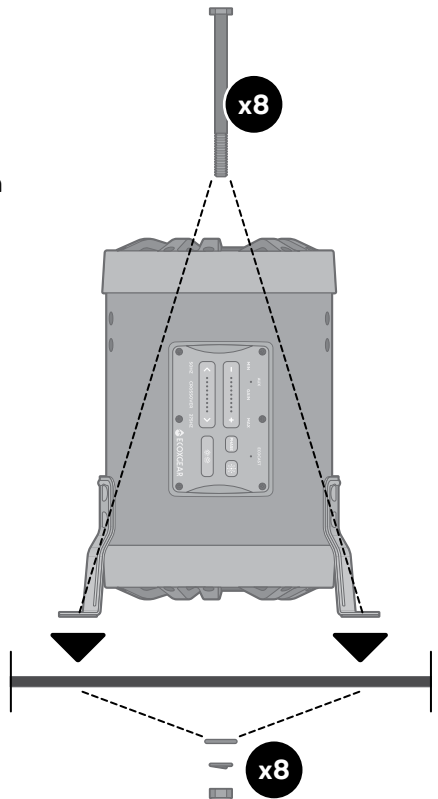
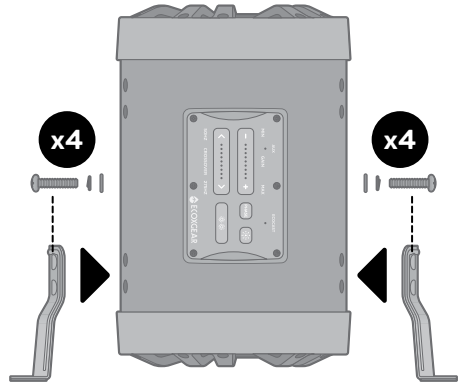

# Troubleshooting

## No audio and LED indicator are off

Check if there is voltage at Power-In connector or if there is an ignition signal when the Auto-Turn-On Switch is set to Remote, or if there is an audio signal input when the Auto-Turn-On Switch is set to Audio.

## Poor audio quality

Check if the Gain Level is set properly. Check wires for shorts or grounds. Check the source signal. Check if the 3.5mm Audio Cable or the Remote Gain Level Controller cable is close to the vehicle's electrical wiring.

## LED Party Lights for show and off-road use only

Check with local ordinance before using LED lights. Do **NOT** drive on public roads with LED lights on. LED lights are not DOT compliant.

## Please do NOT attempt to fix your Extreme Sub

Please contact our Customer Support at [support@gracedigital.com](mailto:support@gracedigital.com) or call us at **800.903.9524**.

# Specifications

## Unit Dimensions

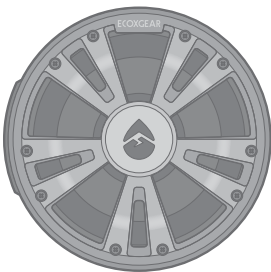

9.1 in / 232 mm



8.9 in / 228 mm

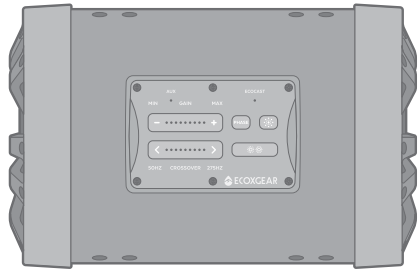

13.9 in / 352 mm

### Unit + Horizontal Mount Dimensions

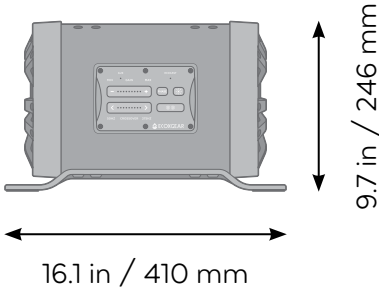

### Unit + Horizontal Mount + Mount Standoffs Dimensions

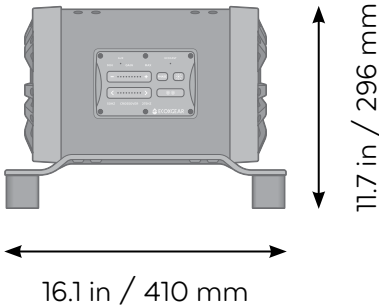

### Unit + Vertical Mount Dimensions

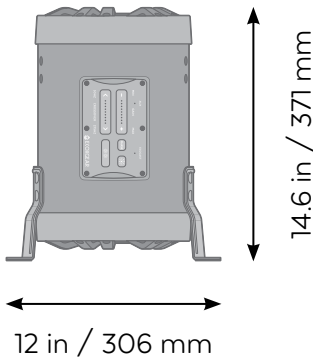

### Unit Weight

16.87 lbs (7.65 kg)

### Horizontal Mount Weight

1.5 lbs (0.68 kg)

### Vertical Mounts Weight

1.28 lbs (0.64 lbs x2)

0.58 kg (0.29 kg x2)

### Bluetooth Compliance

Bluetooth V 5.0

### Bluetooth Frequency Band

2.402-2.480GHz ISM Spectrum

### Modulation

GFSK,  $\pi/4$ -DQPSK, 8DPSK

### Crossover Range

50Hz - 275Hz

### Subwoofer

8" (203.2 mm) subwoofer

### Passive Subwoofer

8" (203.2 mm) subwoofer

### Audio Output Power

500W (peak)

### Power Supply

Input Voltage: 12VDC, 30A

(requires connection to external DC battery for power)

### EcoCast

Using Qualcomm® Broadcast Audio technology

### EcoCast Range

30 ft / 9.1 m between Casting speaker and Receiving speakers

### Blade Fuse

30A, 32V

### Storage Temperature

-40°F to 122°F / -40°C to 50°C

### Operating Temperature

23°F to 95°F / -5°C to 35°C

### Waterproof / Dust Rating

IP66

## FCC STATEMENT:

This device complies with Part 15 of the FCC Rules. Operation is subject to the following two conditions:

- 1.) This device may not cause harmful interference, and
- 2.) This device must accept any interference received, including interference that may cause undesired operation.

**WARNING:** Changes or modifications not expressly approved by the party responsible for compliance could void the user's authority to operate the equipment.

**NOTE:** To maintain compliance with FCC's RF Exposure guidelines, this equipment should be installed and operated with minimum distance between 20cm the radiator to your body: Use only the supplied antenna. FCC ID: 2AAUI-GDIXESW801.

This equipment has been tested and found to comply with the limits for a Class B digital device, pursuant to Part 15 of the FCC Rules. These limits are designed to provide reasonable protection against harmful interference in a residential installation. This equipment generates, uses, and can radiate radio frequency energy and, if not installed and used in accordance with the instructions, may cause harmful interference to radio communications. However, there is no guarantee that interference will not occur in a particular installation. If this equipment does cause harmful interference to radio or television reception, which can be determined by turning the equipment off and on, the user is encouraged to try to correct the interference by one or more of the following measures: reorient or relocate the receiving antenna, increase the separation between the equipment and receiver, connect the equipment into an outlet on a circuit different from that to which the receiver is connected, consult the dealer or an experienced radio/TV technician for help.

## RF WARNING STATEMENT:

The device has been evaluated to meet general RF exposure requirement. The device can be used in portable exposure condition without restriction.

## IC STATEMENT:

This device complies with Industry Canada licence-exempt RSS standard(s). Operation is subject to the following two conditions:

- 1.) This device may not cause interference, and
- 2.) This device must accept any interference, including interference that may cause undesired operation of the device.

## PRODUCT USE AND PROTECTION:

**Read and follow all instructions. Use only as intended.**

The ECOXGEAR subwoofer is intended to be used indoors or outdoors and in land or water environments. The subwoofer has been tested to IP66 waterproofing standards, which means the subwoofer can be exposed to dust and water, but should not be submerged underwater. The subwoofer is **NOT** intended for constant underwater use.

Always make sure the cap(s) / cover(s) are clean, free from sand or debris, and correctly fitted. The subwoofer will only meet IP66 ratings if all rubber seals, gasket(s) and cover(s) / cap(s) are in place. If you notice a muffling of audio after submersion, gently shake the unit to clear excess water. If your subwoofer is exposed to salt water, clean it thoroughly after use with fresh water.

To prevent fire or shock, do **NOT** attempt to power this unit if it is wet or you suspect water has entered the unit. In this situation, please return the unit to Grace Digital for a free assessment. If we have found that the unit has carried water, we will repair or replace the unit free of charge.

## SAFETY ADVISORY & WARNING:

**Read and follow all instructions. Use only as intended.**

**CAUTION:** Do **NOT** open to repair. A qualified technician must carry out repair work.

**ATTENTION:** Do **NOT** connect to a 12VDC power supply while the unit is wet. Make sure all connections are dry **BEFORE** connecting to a power source. Failure to do so may result in electrical damage to the unit and may void the warranty.

**⚠ WARNING:** Cancer and Reproductive Harm - [www.P65Warnings.ca.gov](http://www.P65Warnings.ca.gov)

**WARNING:** Danger of explosion if battery is incorrectly replaced.

**ATTENTION:** Do **NOT** dispose of in a landfill. Contact Grace Digital at [www.gracesupport.com](http://www.gracesupport.com) or a certified recycling agent to dispose of the unit.

## SAFETY:

This product has a limited life span of use and should be replaced when it shows obvious signs of wear.

Do not modify or remove any original component parts of the subwoofer. Doing so could cause damage to the unit, allowing water to ingress. A unit with water ingress should not be charged due to potential risk of fire or shock.

Please exercise care and good judgment when using your ECOXGEAR subwoofer. Audio levels should be appropriate to your environment, comply with all local regulations, and always ensure that you can hear and be aware of any potential hazards around you.

**You should always**

- 1.) Use the ECOXGEAR subwoofer in accordance with any music or noise rules and regulations.
- 2.) Properly seal the ECOXGEAR prior and after each use when in humid or water environments to avoid water damage to the internal components. Salt water / air is particularly corrosive. Always make sure that the gaskets are sealed when in a salt water environment and that the unit is properly rinsed off after use.

- 3.) Properly clean the ECOXGEAR and ensure the gaskets have no sand, dirt, or water on them prior to storage.
- 4.) Store your unit with all caps properly sealed to avoid long term internal moisture damage inside your unit.
- 5.) Return the ECOXGEAR to Grace Digital if you suspect water ingress into the unit or if the unit has experienced a severe impact that may have affected the integrity of the unit to take on water.

**You should never**

- 1.) Never power your ECOXGEAR if you suspect water has entered the device. Powering a device with water inside could be potentially hazardous and cause fire or a spark.
- 2.) Never use your ECOXGEAR if you have dropped it or thrown it against a hard surface which may have destroyed the integrity of the subwoofer, housing, or gaskets. In the event of a severe impact to your unit, please return the unit to Grace Digital to review for potential damage.
- 3.) Never open the auxiliary doors in a water environment. This could cause water to ingress into the unit which could potentially be hazardous and cause a fire or a spark.
- 4.) Never connect a device to the auxiliary input jacks when in a water environment. The auxiliary jacks should only be used in a dry environment.
- 5.) Never attempt to fix, repair your ECOXGEAR unit. Please send it back to Grace Digital for any assessments and repairs.

**CARE, MAINTENANCE & PRECAUTIONS:**

- 1.) The unit is waterproof only when the caps and door are properly closed.
- 2.) Close the caps and door properly before use. If the unit is placed in a water environment without the caps or door properly closed, water may enter into the unit and void your warranty.
- 3.) Dry unit completely before opening the caps. Do **NOT** open the caps if wet or in a wet environment.
- 4.) Do **NOT** apply excessive force to any surfaces of the unit when wet or in a wet environment.
- 5.) Do **NOT** use or store the unit in places with high temperature.
- 6.) **AVOID** prolonged exposure to ultraviolet radiation (UV sunlight) and strong magnetic fields.
- 7.) Periodically check the rubber seal on the caps and door for premature wear.
- 8.) Periodically clean the rubber with a soft moist cloth and ensure no objects such as dirt, hair, sand are on the rubber seal ring. Do **NOT** use any oily solvent or chemicals for cleaning.
- 9.) Rinse off the unit with tap water after use in salt water.
- 10.) Power the unit by attaching the 12VDC Power-In Connector (EC5, male) to the 6.6ft Power Cable (EC5, female) intended for use with the unit. The unit must be connected to a 12VDC, 30A rating power source. If the battery terminal voltage is not 12V, you will need a DC-DC converter with output 12V. Connecting the unit to a non-12VDC power source will lead to a malfunction or damage to the unit.

**LIMITED MANUFACTURER’S WARRANTY:**

Extreme Sub is covered by a 1-year limited warranty that covers defects in workmanship and / or materials for a period of 1 year from original purchase date. This warranty does not apply to any products which have been abused, neglected, modified or used for a purpose other than the one for which they were manufactured. Please refer to the above care and maintenance instructions for suggested care details. The warranty is valid only for the original owner who purchases the unit from an authorized dealer. Transfers do not qualify for warranty protection. Grace Digital reserves the right to replace any out-of-stock or discontinued product with a comparable product. Discontinued products may not be available for warranty replacement. Any contents are **NOT** covered by the limited manufacturer’s warranty. Warranty terms may be revised without notification at the discretion of the manufacturer. Please visit [www.ecoxgear.com](http://www.ecoxgear.com) for additional product & warranty information.



Extreme Sub ES08 by ECOXGEAR, a division of Grace Digital Inc., San Diego, California.  
Designed in California. Made in China.

Patents pending.

## What's in the Box

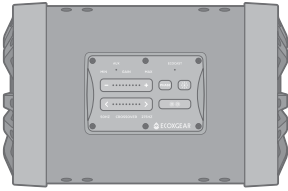

Extreme Sub  
Subwoofer



Extreme Sub  
User Guide



Remote Gain  
Level Controller



6.6ft Power Cable - EC5, Female



6.6ft Remote Turn-On  
Cable - Dark Blue

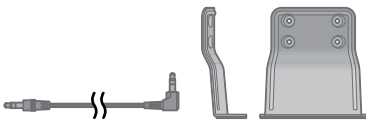

6.6ft 3.5mm Audio Cable      (2pcs) Vertical  
Mounting Plates



(2pcs) Horizontal  
Mount Standoffs



Horizontal Mounting Plate



(8pcs) Lock  
Washers - small



(8pcs) Washers  
- small



(8pcs) 10-24 x 29/32" Stainless  
Steel Button Head Screws



(8pcs) 1/4 Lock  
Washers



(8pcs) 1/4-20  
Nuts



(8pcs) 1/4 Washers



(8pcs) 1/4-20 stainless steel Hex  
Bolts - 3" long



(8pcs) 1/4-20 stainless steel Hex  
Bolts - 3.5" long